



OWNER'S MANUAL



LOMO Series 23

Thank you for choosing our product. Please read this owner's manual carefully before operating the unit and keep it for future reference.

Content

Operation Notices

Precautions	1
Parts Name	5
Indoor Unit Screen Display	6

Remote Control

Buttons on remote control	7
Introduction for icons on remote control	8
Operation of remote control	9
Special functions	12
Replacement of batteries in remote controller	13
Emergency operation	14

Maintenance

Clean and Maintenance	15
-----------------------------	----

Malfunction

Malfunction analysis	17
----------------------------	----

Installation Notice

Installation dimension diagram	21
Tools for installation	22
Selection of installation location	22
Requirements for electric connection	23

Installation

Installation of indoor unit	24
Installation of outdoor unit	29
Vacuum pumping	32
Leakage detection	32
Check after installation	33

Test and operation

Test operation	33
----------------------	----

Attachment

Configuration of connection pipe	34
Pipe expanding method	36
Wired Controller	37

This appliance is not intended for use by persons (including children) with reduced physical, sensory or mental capabilities, or lack of experience and knowledge, unless they have been given supervision or instruction concerning use of the appliance by a person responsible for their safety. Children should be supervised to ensure that they do not play with the appliance.



DANGER

Indicates a hazardous situation that, if not avoided, will result in death or serious injury.



WARNING

Indicates a hazardous situation that, if not avoided, could result in death or serious injury.



CAUTION

Indicates a hazardous situation that, if not avoided, may result in minor or moderate injury.

NOTICE

Indicates important but not hazard-related information, used to indicate risk of property damage.



Indicates a hazard and it is assigned to the signal words DANGER, WARNING or CAUTION.

Precautions



WARNING

Operation and Maintenance

- This appliance can be used by children aged from 8 years and above and persons with reduced physical, sensory or mental capabilities or lack of experience and knowledge if they have been given supervision or instruction concerning use of the appliance in a safe way and understand the hazards involved.
- Children shall not play with the appliance.
- Cleaning and user maintenance shall not be made by children.
- Do not connect air conditioner to multi-purpose socket. Otherwise, it may cause fire hazard.
- Do disconnect power supply when cleaning air conditioner. Otherwise, it may cause electric shock.
- If the supply wire is damaged, it must be replaced by the manufacturer, its service agent or similarly qualified persons in order to avoid a hazard.
- Do not wash the air conditioner with water to avoid electric shock.
- Do not spray water on indoor unit. It may cause electric shock or malfunction.
- After removing the filter, do not touch fins to avoid injury.
- Do not use fire or hair dryer to dry the filter to avoid deformation or fire hazard.

Precautions



Operation and Maintenance

- Maintenance must be performed by qualified professionals. Otherwise, it may cause personal injury or damage.
- Do not repair air conditioner by yourself. It may cause electric shock or damage. Please contact dealer when you need to repair air conditioner.
- Do not extend fingers or objects into air inlet or air outlet. It may cause personal injury or damage.
- Do not block air outlet or air inlet. It may cause malfunction.
- Do not spill water on the remote control, otherwise the remote control may be broken.
- When below phenomenon occurs, please turn off air conditioner and disconnect power immediately, and then contact the dealer or qualified professionals for service.
 - There's abnormal sound during operation.
 - Circuit break trips off frequently.
 - Air conditioner gives off burning smell.
 - Indoor unit is leaking.
- If the air conditioner operates under abnormal conditions, it may cause malfunction, electric shock or fire hazard.
- When turning on or turning off the unit by emergency operation switch, please press this switch with an insulating object other than metal.
- Do not step on top panel of outdoor unit, or put heavy objects. It may cause damage or personal injury.

Precautions**WARNING****Attachment**

- Installation must be performed by qualified professionals. Otherwise, it may cause personal injury or damage.
- Must follow the electric safety regulations when installing the unit.
- According to the local safety regulations, use qualified power supply circuit and circuit break.
- Install a circuit breaker of adequate capacity only used for the system; otherwise, it may cause malfunction.
- An all-pole disconnection switch having a contact separation of at least 3mm in all poles should be connected in fixed wiring.
- Air Conditioner should be properly grounded. Incorrect grounding may cause electric shock.
- Make sure the power supply matches with the requirement of air conditioner. Unstable power supply or incorrect wiring may cause malfunction of the unit, electric shock or fire hazard
- Properly connect the live wire, neutral wire and grounding wire.
- Be sure to cut off the power supply before proceeding any work related to electricity and safety.

Precautions



- Do not put through the power before finishing installation.
- If the supply cord is damaged, it must be replaced by the manufacturer, its service agent or similarly qualified persons in order to avoid a hazard.
- The temperature of refrigerant circuit will be high, please keep the interconnection cable away from the copper tube.
- The appliance shall be installed in accordance with national wiring regulations.
- Installation must be performed in accordance with the requirement of NEC and CEC by authorized personnel only.
- The air conditioner is a first class electric appliance. It must be properly grounded with specialized grounding device by a professional. Please make sure it is always grounded effectively, otherwise it may cause electric shock.
- The yellow-green wire in the air conditioner is the grounding wire, which can't be used for other purposes.
- The grounding resistance should comply with national electric safety regulations.
- All wires of indoor unit and outdoor unit should be connected by a professional.
- If the length of power connection wire is insufficient, please contact the supplier for a new one. Do not extend the wire yourself.

Precautions**WARNING**

- If you need to relocate the air conditioner to another place, only a qualified person can perform the work. Otherwise, it may cause personal injury or damage.
- Select a location which is out of reach for children and far away from animals or plants. If it is unavoidable, please add the fence around the outdoor unit for safety purpose.
- The indoor unit should be installed close to the wall.
- Instructions for installation and use of this product are provided by the manufacturer.

Working temperature range

	Indoor side DB/WB(°C)	Outdoor side DB/WB(°C)
Maximum cooling	26.7/19.4 (80/66.9)	46.1/23.9 (115/75)
Maximum cooling	26.7/- (80/-)	23.9/18.3 (75/64.9)

NOTICE :

- The operating temperature range (outdoor temperature) for cooling only unit is -18 (-0.4°F)~46.1°C (115°F) ; for heat pump unit is -20°C (-4°F)~46.1°C (115°F).

Parts Name

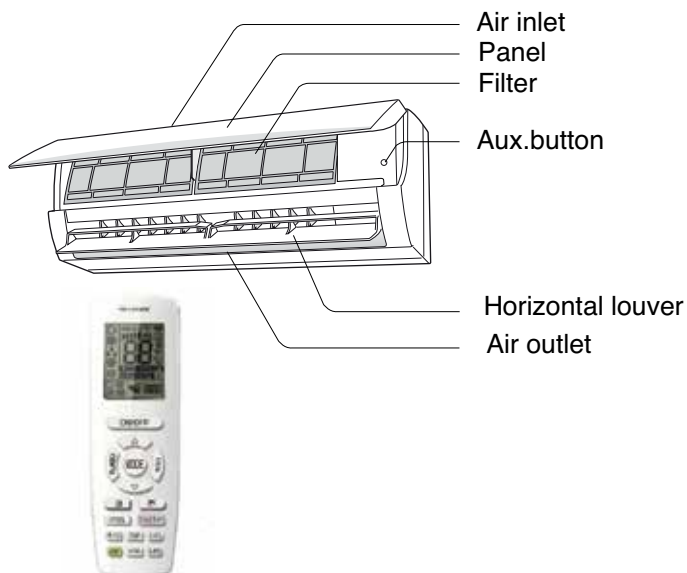
Indoor Unit

Remote control

AVIS :

(Display content or position may be different from above graphics, please refer to actual products)

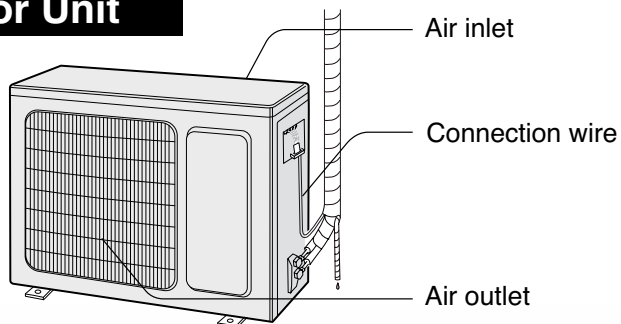
Outdoor Unit**NOTICE :**

Actual product may be different from above graphics, please refer to actual products.

Indoor Unit Screen Display

Display and icons position may vary with models

For some model:

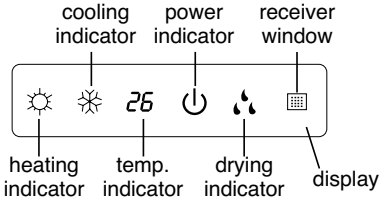

For some model:

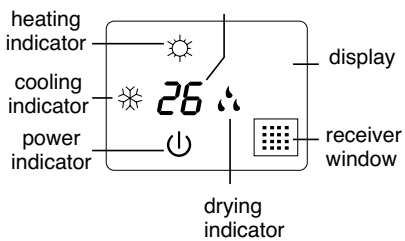

For some model:

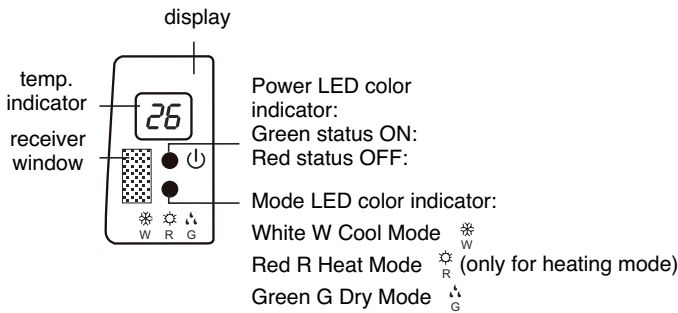

For some model:

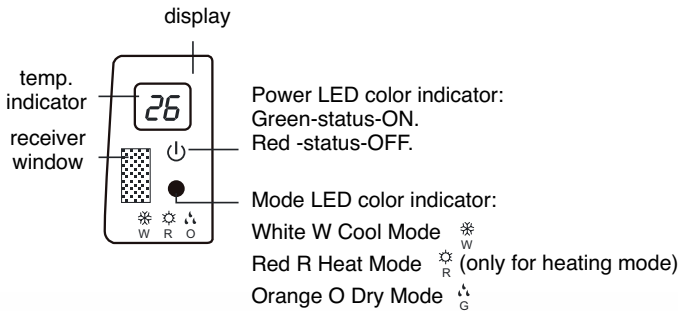

Display content or position may be different from above graphics, please refer to actual products.

Remote Control:

Button name and function introduction

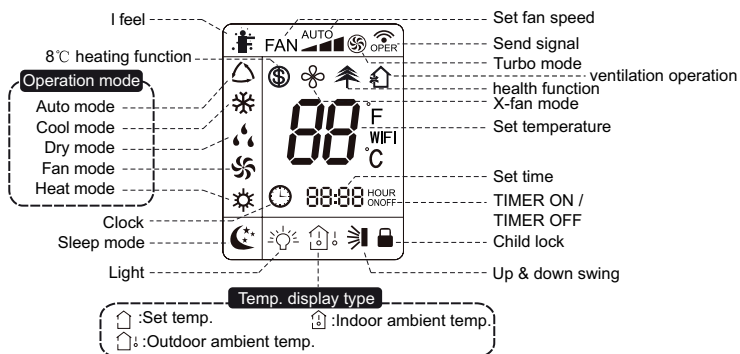

Introduction for buttons on remote controller

This is a general use remote controller, it could be used for the air conditioners with multifunction; For some function, which the model doesn't have, if press the corresponding button on the remote controller that the unit will keep the original running status.

After putting through the power, the air conditioner will give out a sound. Operation indicator "⏻" is ON (red indicator). After that, you can operate the air conditioner by using remote controller.

Under on status, pressing the button on the remote controller, the signal icon "📶" on the display of remote controller will blink once and the air conditioner will give out a "bip" sound, which means the signal has been sent to the air conditioner.

- Under off status, set temperature and clock icon will be displayed on the display of remote controller (If timer on, timer off and light functions are set, the corresponding icons will be displayed on the display of remote controller at the same time); Under on status, the display will show the corresponding set function icons.

1 ON/OFF button.

Press this button to turn on the unit. Press this button again to turn off the unit.

2 ▲ button.

Press this button to increase set temperature. Holding it down above 2 seconds rapidly increases set temperature. In AUTO mode, set temperature is not adjustable.

3 MODE button

Each time you press this button, a mode is selected in a sequence that goes from AUTO, COOL, DRY, FAN, and HEAT *, as the following:.

AUTO ► COOL ► DRY ► FAN ► HEAT*

↑ _____ * Note: Only for models with heating function.

After energization, AUTO mode is defaulted. In AUTO mode, the set temperature will not be displayed on the LCD, and the unit will automatically select the suitable operation mode in accordance with the room temperature to make indoor room comfortable.

Introduction for buttons on remote controller

9 TIMER ON button

Press this button to initiate the auto-ON timer. To cancel the auto-timer program, simply press this button again. After press of this button,  disappears and "ON "blinks. 00:00 is displayed for ON time setting. Within 5 seconds, press ▲ or ▼ button to adjust the time value. Every press of either button changes the time setting by 1 minute. Holding down either button rapidly changes the time setting by 1 minute and then 10 minutes. Within 5 Seconds after setting, press TIMER ON button to confirm.

10 Sleep button

Press this button to go into the SLEEP operation mode. Press it again to cancel this function. This function is available in COOL, HEAT (Only for models with heating function) to maintain the most comfortable temperature for you.

11 TIMER ON button

Press this button, you can see indoor set temperature, indoor ambient temperature on indoor unit's display. The setting on remote controller is selected circularly as below:

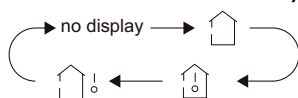

When selecting "🏠" with remote controller or no display, temperature indicator on indoor unit displays set temperature; When selecting "🏠°" with remote controller, temperature indicator on indoor unit displays indoor ambient temperature; 3s later or within 3s it receives other remote controller signal that will return to display the setting temperature.

CAUTION:

- This model hasn't door ambient temperature display function. White remote controller can operate "🏠°" and indoor unit displays set temperature.
- It's defaulted to display set temperature when turning on the unit.
- Only for the models with temperature indicator on indoor unit.



Introduction for buttons on remote controller

12 TURBO button

Press this button to activate / deactivate the Turbo function which enables the unit to reach the preset temperature in the shortest time. In COOL mode, the unit will blow strong cooling air at super high fan speed. In HEAT mode, the unit will blow strong heating air at super high fan speed.

13 X-FAN button





X-FAN function: In COOL or DRY mode, the icon  is displayed and the indoor fan will continue operation for 2 minutes in order to dry the indoor unit even though you have turned off the unit. After energization, X-FAN OFF is defaulted. X-FAN is not available in AUTO, FAN or HEAT mode.

 function: turn on the display's light and press this button again to turn off the display's light. If the light is turned on,  is displayed. If the light is turned off,  disappears.

14 I FEEL button



Press this button to turn on I FEEL function. The unit automatically adjust temperature according to the sensed temperature. Press this button again to cancel FEEL function.

15 button

Press this button to achieve the on and off of healthy and scavenging functions in operation status. Press this button for the first time to start scavenging function; LCD displays "". Press the button for the second time to start healthy and scavenging functions simultaneously; LCD displays "" and "". Press this button for the third time to quit healthy and scavenging functions simultaneously. Press the button for the fourth time to start healthy function; LCD display "". Press this button again to repeat the operation above. (This function is applicable to partial of models)

Fonctionnement des boutons de la télécommande

Combinaison de "▲" and "▼" buttons: About lock

Press "▲" and "▼" buttons simultaneously to lock or unlock the keypad. If the remote controller is locked,  is displayed. In this case, pressing any button,  blinks three times.

Combinaison de "MODE" and "▼" buttons: About switch between Fahrenheit and centigrade

At unit OFF, press "MODE" and "▼" buttons simultaneously to switch between °C and °F .

Combinaison de "TEMP" and "CLOCK" buttons: About Energy-saving Function

Press "TEMP" and "CLOCK" simultaneously in COOL mode to start energy-saving function. Nixie tube on the remote controller displays "SE". Repeat the operation to quit the function.

Combinaison de "TEMP" and "CLOCK" buttons: About 8°C Heating Function

Press "TEMP" and "CLOCK" simultaneously in HEAT mode to start 8°C Heating Function Nixie tube on the remote controller displays "8" and a selected temperature of "8°C". (46°F if Fahrenheit is adopted). Repeat the operation to quit the function.

WIFI Function*

Press "MODE" and "TURBO" button simultaneously to turn on or turn off WIFI function. When WIFI function is turned on, the "WiFi" icon will be displayed on remote controller; Long press "MODE" and "TURBO" buttons simultaneously for 10s, remote controller will send WIFI reset code and then the WIFI function will be turned on. WIFI function is defaulted ON after energization of the remote controller.

*Optional

Using the Remote Control

1. After putting through the power, press "ON/OFF" button on remote controller to turn on the air conditioner.
2. Press "MODE" button to select your required mode: AUTO, COOL, DRY, FAN, HEAT.
3. Press "▲" or "▼" button to set your required temperature. (Temperature can't be adjusted under auto mode).
4. Press "FAN" button to set your required fan speed: auto, low, medium and high speed.
5. Press "SWING" button to select fan blowing angle.

In winter, absence function can keep the indoor ambient temperature above 0°C to avoid freezing.

Note: Absence function is only available in heating mode and it will be exited when switching mode or setting sleep function.

1.5 Replacing batteries in remote control

- (1). Lift the cover along the direction of arrow (as shown in Fig 1 ①).
- (2). Take out the original batteries (as shown in Fig 1 ②).
- (3). Place two 7# (AAA 1.5V) dry batteries, and make sure the position of + and - terminals is correct (as shown in Fig 2 ③).
- (4). Reinstall the cover (as shown in Fig 2 ④).

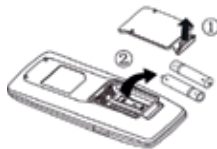

Fig.1



Fig.2

Notes:

- ①. The remote controller should be placed 1m away from the TV set or stereo sound sets.
- ②. The operation of remote controller should be performed within its receiving range.
- ③. If you need to control the main unit, please point the remote controller at the signal receiving window of the main unit to improve the receiving sensibility of main unit.
- ④. When the remote controller is sending signal, " " icon will be blinking for 1 second. When the main unit receives valid remote control signal, it will give out a sound.
- ⑤. If the remote controller does not operate normally, please take the batteries out and reinsert them after 30 seconds. If it still can't operate properly, replace the batteries.
- ⑥. When replacing the batteries, do not use old or different types of batteries, otherwise, it may cause malfunction.
- ⑦. When you won't use the remote controller for a long time, please take out the batteries.

Emergency operation

If the remote control is lost or damaged, please use auxiliary button to turn on or turn off the air conditioner. As shown in the figure, open the panel, press the auxiliary button to turn on or turn off the air conditioner. When the air conditioner is turned on, it will operate under auto mode.

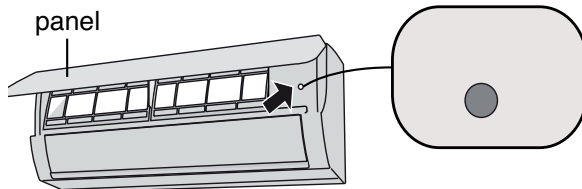

WARNING

Use insulated object to press the auto button

Clean and Maintenance



WARNING

- Turn off the air conditioner and disconnect the power before cleaning the unit to avoid electric shock.
- Do not wash the air conditioner with water to avoid electric shock.
- Do not use volatile liquid to clean the air conditioner.

Clean surface of indoor unit

When the surface of indoor unit is dirty, it is recommended to use a soft dry cloth or lightly moistened with water to wipe it.

NOTICE:

- Do not remove the panel when cleaning it.

Clean and maintenance

Clean filter

1 Open panel

Open the panel into a certain angle (less than 60° , do not force the panel) along the arrow direction from the two sides of panel.

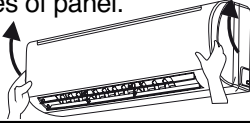

2 Remove filter

Remove the filter as indicated.

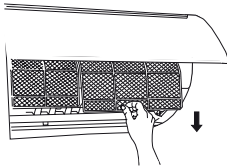

3 Clean filter

- Use a vacuum or water to clean the filter.
- When the filter is very dirty, use water (below 45°C) to clean it, and then put it in a shady and cool place to dry.

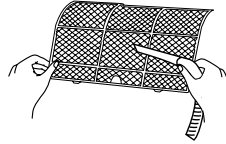

4 Install filter

Install the filter and then close the panel cover tightly.



⚠ WARNING

- The filter should be cleaned every three months. If the unit operates in a highly dusty environment, clean frequency should be increased.
- After removing the filter, do not touch fins to avoid injury.
- Do not use fire or hair dryer to dry the filter to avoid deformation or fire hazard.

Clean and Maintenance

1. Check that air inlets and air outlets are not blocked.
2. Check if circuit breaker and connection, are in good condition.
3. Check that filters are clean.
4. Check that drainage pipe is not damaged.

1. Disconnect power supply.
2. Clean filters and indoor unit's panel.
3. Check whether mounting bracket for outdoor unit is damaged or corroded.
If yes, please contact dealer.

Notice for recovery

1. Many packing materials are recyclable.
Please dispose of them in appropriate recycling bin.
2. If you want to get rid of the air conditioner, please contact local dealer or recycling service center for the correct disposal method.

Malfunction analysis

Please check below items before asking for maintenance. If the malfunction still can't be eliminated, please contact local dealer or qualified professionals.

Problem	Check items	Solution
Indoor unit can't receive remote control signal or remote control has no power.	Whether it's interfered severely (such as static electricity, stable voltage)?	Cut the power supply off and put the power back after about 3min, and then turn on the unit again.
	Whether remote control is within the signal receiving range?	Signal receiving range is 8m.
	Whether there are obstacles?	Remove obstacles.
	Whether remote control is pointing at the receiving window?	Select proper angle and point the remote control at the receiving window on indoor unit.
	Is the remote control display fuzzy or there is no display at all ?	Check the batteries. If the battery charge level is too low, please replace them.
	No display when operating the remote control?	Check whether remote control appears to be damaged. If yes, replace it.
	Fluorescent lamp in the room?	Bring the remote control close to the indoor unit. Turn off the fluorescent lamp and then try it again.
No air flow from indoor unit	Are air inlet or air outlet of indoor unit blocked?	Eliminate obstacles.
	Under heating mode, indoor temperature reached set temperature?	After reaching set temperature, indoor unit will stop blowing out air.
	Has the heating mode been just turned on ?	In heating mode, in order to prevent blowing out cold air, indoor unit will start several minutes after the unit has been turned on, which is normal.

Malfunction analysis

Problem	Check items	Solution
Air conditioner can't operate	Power failure?	Wait until power resumes.
	Air switch trips off ?	Ask professional to replace air switch.
	Wiring has malfunction?	Ask professional to replace it.
	Has the unit been turned on immediately after being stopped ?	Wait for 3min, and then turn on the unit again.
	Is the function setting on remote control correct ?	Reset the function.
Mist is emitted from indoor unit's air outlet	Are indoor temperature and humidity level high ?	This is because indoor air is cooled rapidly. After a while, indoor temperature and humidity level will decrease and mist will disappear.
Set temperature can't be adjusted	Unit is operating under auto mode?	Temperature can't be adjusted under auto mode. Please switch the operation mode if you need to adjust temperature.
	Your required temperature exceeds the set temperature range?	Set temperature range: 15°C -30 °C .
Air cooling (heating) is not efficient	Voltage is too low?	Wait until the voltage resumes to normal.
	Filter is dirty?	Clean the filter.
	Set temperature is in proper range?	Adjust temperature to proper range.
	Doors and windows are open?	Close doors and windows.

Malfunction analysis

Problem	Check items	Solution
Odours are emitted	Either there is an odour source in the room, such as furniture or cigarette, or the filter is dirty.	Eliminate the source of the odour. Clean the filter.
Air conditioner suddenly turns on and operates normally	There may be interference, such as thunder, wireless devices, etc.	Cut the power supply off and put the power back and then turn on the unit again.
Outdoor unit emits vapor	Heating mode is turned on?	During defrosting under heating mode, it may produce vapor, which is a normal.
Water flowing noise	Has the air conditioner just been turned on and off?	The noise is the sound of refrigerant flowing inside the unit, which is a normal.
Craking noise	Has the air conditioner just been turned on and off?	This is the sound of friction caused by expansion and/or contraction of panel or other parts due to the change of temperature.

Malfunction analysis

Error code

When air conditioner status is abnormal, temperature indicator on indoor unit will blink and display corresponding error code. Please refer to list below for identification of error code.

Error code	Troubleshooting
E5	It can be eliminated after restarting the unit. If not , please contact qualified professionals for service.
E6	It can be eliminated after restarting the unit. If not , please contact qualified professionals for service.
E8	It can be eliminated after restarting the unit. If not,please contact qualified professionals for service.
U8	It can be eliminated after restarting the unit. If not,please contact qualified professionals for service.
H6	It can be eliminated after restarting the unit. If not,please contact qualified professionals for service.
C5	Please contact qualified professionals for service.
F1	Please contact qualified professionals for service.
F2	Please contact qualified professionals for service.

Note: If there're other error codes, please contact qualified professionals for service.

▲WARNING

- When situations below happen, please turn off the air conditioner and disconnect power immediately, then contact the dealer or qualified professionals for service.
- There is an unusual sound during operation.
- Air switch trips off frequently.
- Air conditioner generates a burning smell.
- Indoor unit is leaking.

ATTENTION:

- Do not repair or refit the air conditioner by yourself.
- If the air conditioner operates under abnormal conditions, it may damage the unit, or cause electric shock or fire hazard.

Installation dimension diagram

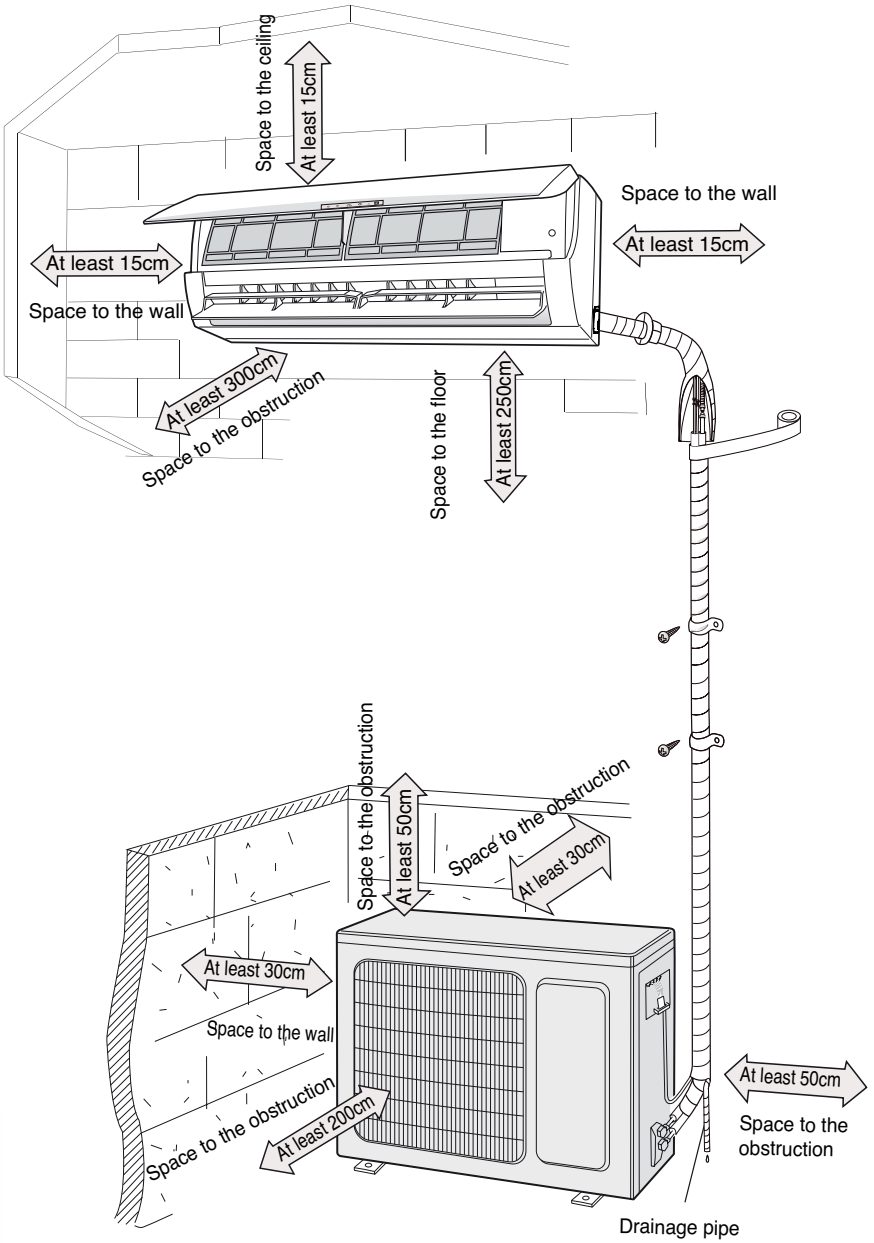

Tools for installation

1 Level meter	2 Screw driver	3 Impact drill
4 Drill head	5 Pipe expander	6 Torque wrench
7 Open-end wrench	8 Pipe cutter	9 Leakage detector
10 Vacuum pump	11 Manometer	12 Universal meter
13 Inner hexagon spanner		14 Measuring tape

Note:

- Contact your local agent or a certified technician for installation.

Selection of installation location

Basic requirement

Installing the unit in the following places may cause malfunction. If it is unavoidable, please consult your local dealer or a certified technician:

1. A place with strong heat sources, vapors, flammable or explosive gas, or volatile objects spread in the air.
2. A place with high-frequency devices (such as welding machine, medical equipment).
3. A place near coast area.
4. A place with oil or fumes in the air.
5. A place with sulphurous gas.
6. Other places with special environment.
7. The appliance cannot be installed in a laundry.

Indoor unit

1. There should be no obstruction near air inlet and air outlet.
2. Select a location where the condensation water can be dispersed easily and won't affect people.
3. Select a location which is convenient to connect the outdoor unit and the closest possible to the power supply.
4. Select a location which is out of reach for children.
5. The location should be able to withstand the weight of indoor unit and won't increase noise and vibration.
6. The appliance must be installed 2.5m above floor.
7. Don't install the indoor unit right above an electric appliance.
8. Please try your best to keep the unit away from fluorescent lamps.

Outdoor unit

1. Select a location where the noise and outflow air emitted by the outdoor unit will not affect neighborhood.
2. The location should be well ventilated and dry, where the outdoor unit won't be exposed directly to sunlight or strong wind.
3. The location should be able to withstand the weight of outdoor unit.
4. Make sure that the installation follows the requirement of installation dimension diagram.
5. Select a location which is out of reach for children and far away from animals or plants. If it is unavoidable, please add a fence for safety purpose.

Requirements for electric connection

Safety precaution

1. Must follow the electric safety regulations when installing the unit.
2. According to the local safety regulations, use qualified power supply circuit and air switch.
3. Make sure the power supply matches with the requirement of air conditioner. Unstable power supply or incorrect wiring may cause mal function and damage the unit.
4. Properly connect the live wire, neutral wire and grounding wire
5. To work safely, be sure to cut off the power supply before proceeding any work related to electricity.
6. Do not put through the power before finishing installation.
7. The temperature of refrigerant circuit will be high, please keep the interconnection cable away from the copper tube.
8. The appliance shall be installed in accordance with national wiring regulations.

Grounding requirement

1. The air conditioner is a first class electric appliance. It must be properly grounded with specialized grounding device by a professional. Please make sure it is always grounded effectively, otherwise it may cause electric shock.
2. The yellow-green wire in air conditioner is the grounding wire, which can't be used for other purposes.
3. The grounding resistance should comply with national electric safety regulations.
4. An all-pole disconnection switch having a contact separation of at least 3mm in all poles should be connected in fixed wiring.

Installation of indoor unit

Step One: choosing installation location

Recommend the installation location to the client and then confirm it with the client.

Step Two: install wall-mounting frame

1. Hang the wall-mounting frame on the wall; adjust it in horizontal position with the level meter and then point out the screw fixing holes on the wall.
2. Drill the screw fixing holes on the wall with the impact drill (the specification of drill head should be the same as the plastic expansion particle) and then fill the plastic expansion particles in the holes.
3. Fix the wall-mounting frame on the wall with tapping screws (ST4.2X25TA) and then check if the frame is firmly installed by pulling the frame. If the plastic expansion particle is loose, please drill another fixing hole nearby.

Step Three: open piping hole

1. Choose the position of piping hole according to the direction of outlet pipe. The position of piping hole should be a little lower than the wall-mounted frame, shown as below.

09K:

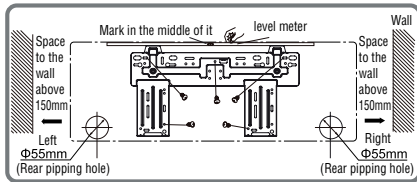

12K:

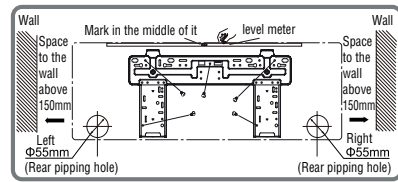

18K:

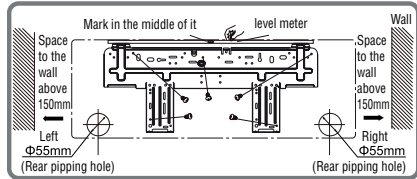

24K:

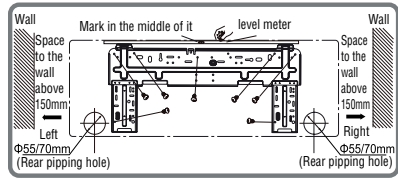

2. Open a piping hole with the diameter of $\Phi 55$ or $\Phi 70$ on the selected outlet pipe position. In order to drain smoothly, slant the piping hole on the wall slightly downward to the outdoor side with the gradient of 5-10°.

Installation of the indoor unit

Note:

- Pay attention to dust prevention and take relevant safety measures when opening the hole.
- The plastic expansion particles are not provided and should be bought locally.

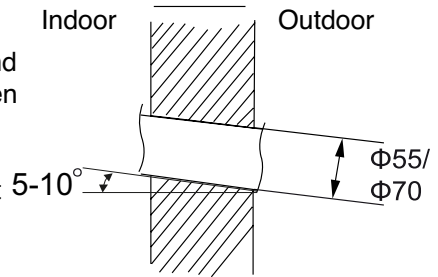

Step Four: outlet pipe

1. The pipe can be led out in the direction of right, rear right, left or rear left.

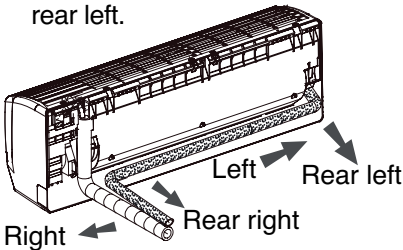

2. When select leading out the pipe from left or right, please cut off the corresponding hole on the bottom case.

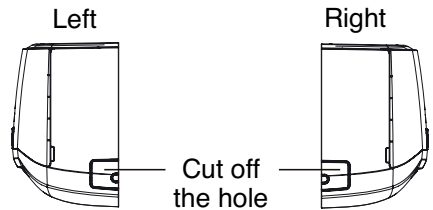

Step Five: connect the pipe of indoor unit

1. Aim the pipe joint at the corresponding bell mouth.

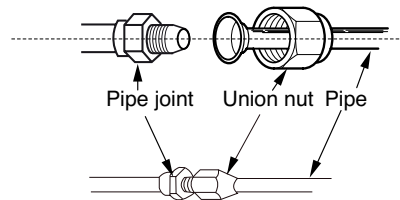

2. Pretightening the union nut with hand.

3. Adjust the torque force by referring to the following sheet. Place the open-end wrench on the pipe joint and place the torque wrench on the union nut. Tighten the union nut with torque wrench.

Installation of indoor unit

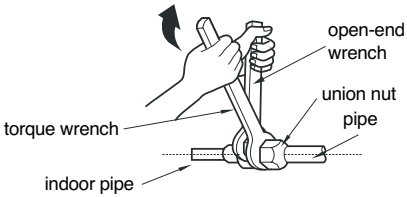

Hex nut diameter	Tightening torque (N·m)
Φ 6	15~20
Φ 9.52	30~40
Φ 12	45~55
Φ 16	60~65
Φ 19	70~75

4. Wrap the indoor pipe and joint of connection pipe with insulating pipe, and then wrap it with tape.

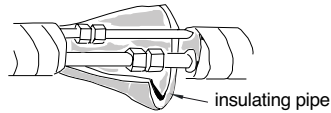

Step Six: install drain hose

1. Connect the drain hose to the outlet pipe of indoor unit.

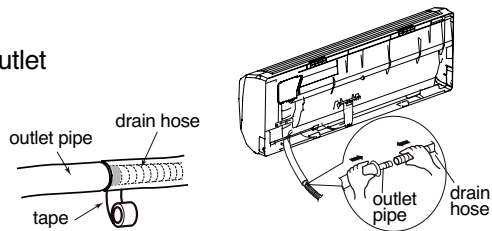

2. Bind the joint with tape.

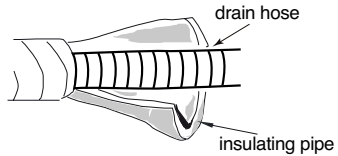

Note:

- Add insulating pipe in the indoor drain hose in order to prevent condensation.
- The plastic expansion particles are not provided.

Step Seven: connect wire of indoor unit

1. Open the panel, remove the screw on the wiring cover and then take down the cover.

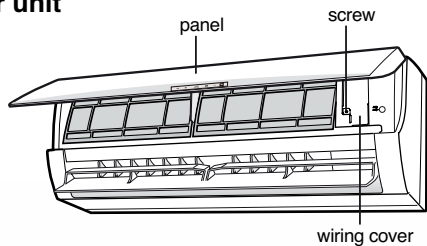

Installation of indoor unit

2. Make the power connection wire go through the cable-cross hole at the back of indoor unit and then pull it out from the front side.

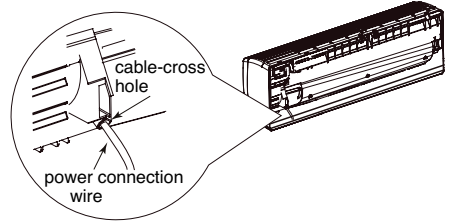

3. Remove the wire clip; connect the power connection wire to the wiring terminal according to the color; tighten the screw and then fix the power connection wire with wire clip. After finishing wiring, clamp the grounding wire (yellow-green wire) into the wire-crossing groove as shown in the following figure, in order to avoid pressing the wire when closing the electric box cover.

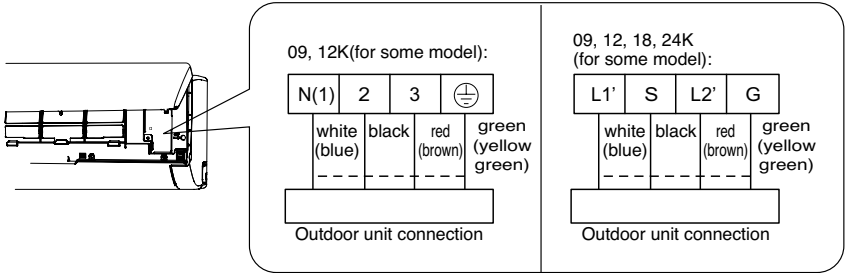

Note: the wiring board is for reference only, please refer to the actual one.

- 4. Put wiring cover back and then tighten the screw
- 5. Close the panel.

- Note:**
- All wires of indoor unit and outdoor unit should be connected by a professional.
 - If the length of power connection wire is insufficient, please contact the supplier for a new one. Avoid extending the wire by yourself.
 - An air switch must be installed in the line. The air switch should be all-pole parting and the contact parting distance should be more than 3mm.

Installation of indoor unit

Step Eight: bind up pipe

1. Bind up the connection pipe, power cord and drain hose with the band.

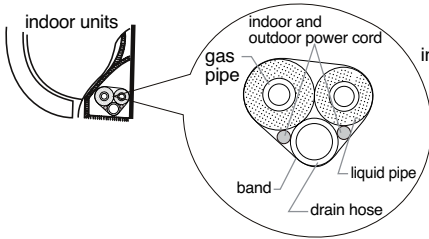
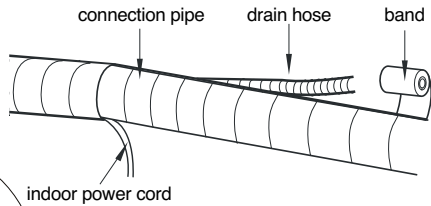

3. Bind them evenly.
4. The liquid pipe and gas pipe should be bound separately at the end.

2. Reserve a certain length of drain hose and power cord for installation when binding them. When binding to a certain degree, separate the indoor power and then separate the drain hose.

Note:

- The power cord and control wire can't be crossed or winded.
- The drain hose should be bound at the bottom.

Step Nine: hang the indoor unit

1. Put the bound pipes in the wall pipe and then make them pass through the wall hole.
2. Hang the indoor unit on the wall-mounting frame.
3. Stuff the gap between pipes and wall hole with sealing gum.
4. Fix the wall pipe.
5. Check if the indoor unit is installed firmly and close to the wall.

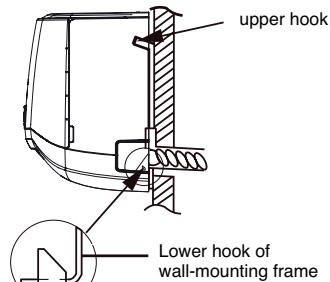
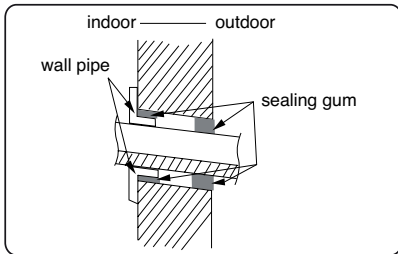

Note:

- Do not bend the drain hose too excessively in order to prevent blocking.

Installation of outdoor unit

Step one: fix the support of outdoor unit (select it according to the actual installation situation)

1. Select installation location according to the house structure.
2. Fix the support of outdoor unit on the selected location with expansion screws.

Note:

- Take sufficient protective measures when installing the outdoor unit.
- Make sure the support can withstand at least four times the unit weight.
- The outdoor unit should be installed at least 3cm above the floor in order to install drain joint.

- Expansion screws needed per type of unit:

Cooling capacity	# screws
2300-5000W	6
6000-8000W	8
10000-16000W	10

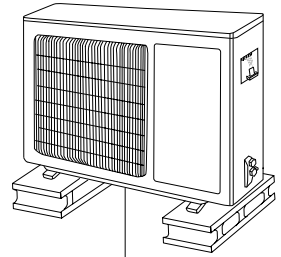

at least 3cm above the floor

Step two: install drain joint (Only for cooling and heating unit)

1. Connect the outdoor drain joint into the hole on the chassis, as shown in the picture below.
2. Connect the drain hose into the drain vent.

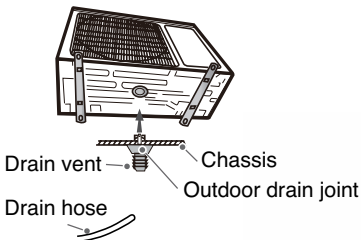

Step three: fix outdoor unit

1. Place the outdoor unit on the support.
2. Fix the foot holes of outdoor unit with bolts.

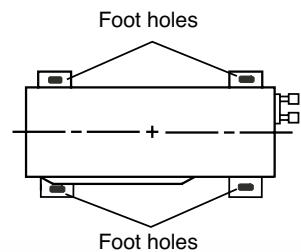

Installation of outdoor unit

- Fix the power connection wire and signal control wire with wire clip (only for cooling and heating unit).

Note:

- After tightening the screw, pull the power cord slightly to check if it is solid.
- Never cut the power connection wire to extend or shorten the distance.

Step Six: Pipe arrangement

- The pipes should be placed along the wall, bent reasonably and hidden possibly. Min. semi-diameter of bending the pipe is 10cm.
- If the outdoor unit is higher than the wall hole, you must set a U-shaped curve in the pipe before pipe goes into the room, in order to prevent rain from getting into the room.

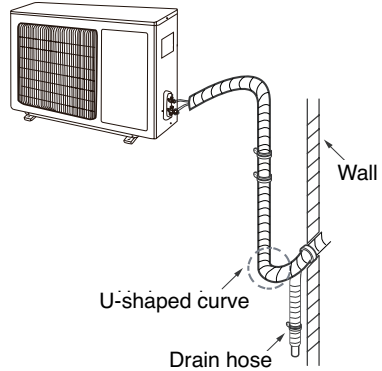

NOTES:

- The through-wall height of drain hose shouldn't be higher than the outlet pipe hole of indoor unit.
- Slant the drain hose slightly downwards; the drain hose can't be curved, raised, wavy, etc.

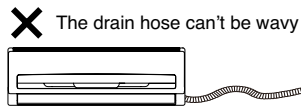
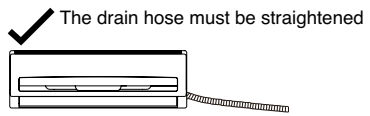
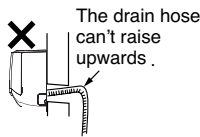
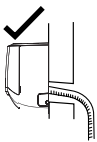

- The water outlet can't be placed in water in order to drain smoothly.

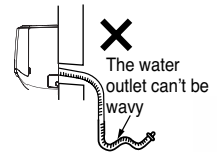
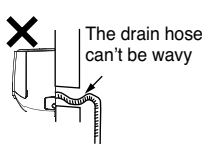
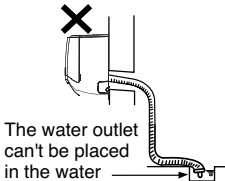

Vacuum pumping

Use vacuum pumping

1. Remove the valve caps on the liquid valve and gas valve and the nut of refrigerant charging vent.
2. Connect the charging hose of piezometer to the refrigerant charging vent of gas valve and then connect the other charging hose to the vacuum pump.
3. Open the piezometer completely and operate for 10-15min to check if the pressure of piezometer remains in -0.1 MPa.
4. Close the vacuum pump and maintain this status for 1-2min to check if the pressure of piezometer remains in -0.1 MPa. If the pressure decreases, there may be leakage.
5. Remove the piezometer, open the valve core of liquid valve and gas valve completely with inner hexagon spanner.
6. Tighten the screw caps of valves and refrigerant charging vent.

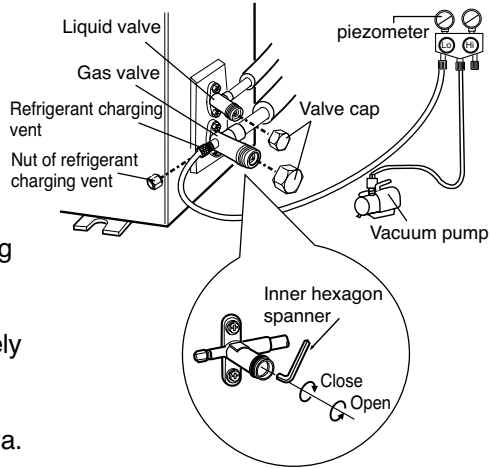

Leakage detection

1. With a leakage detector, check if there is leakage.
2. If leakage detector is not available, please use soap water for leakage detection.
Apply soap water at the suspected position and keep the soap water for more than 3min. If there are air bubbles coming out of this position, there's a leakage.

Check after installation

- Check according to following after finishing installation.

Items to be checked	Possible malfunction
Has the unit been installed solidly?	The unit may drop, shake or emit noise.
Have you done the refrigerant leakage test?	It may cause insufficient cooling (heating) capacity.
Is heat insulation of pipeline sufficient?	It may cause condensation and water dripping.
Is water drained well?	It may cause condensation and water dripping.
Is the voltage of power supply according to the voltage marked on the nameplate?	It may cause malfunction or damaging the parts.
Is electric wiring and pipeline installed correctly?	It may cause malfunction or damaging the parts.
Is the unit grounded securely?	It may cause electric leakage.
Does the power wire follow the specification?	It may cause malfunction or damaging the parts.
Is there any obstruction in the air inlet and outlet?	It may cause insufficient cooling (heating) capacity.
The dust and sundries caused during installation are removed?	It may cause malfunction or damaging the parts.
The gas valve and liquid valve of connection pipe are open completely?	It may cause insufficient cooling (heating) capacity.

Check after installation

1. Preparation of test operation

- The client approves the air conditioner.
- Specify the important notes for air conditioner to the client.

2. Method of test operation

- Put through the power, press ON/OFF button on the remote controller to start operation.
- Press MODE button to select AUTO, COOL, DRY, FAN and HEAT to check whether the operation is normal or not.
- If the ambient temperature is lower than 16°C , the air conditioner can't start cooling.

Configuration of connecting pipe

1. Standard length of connection pipe
 - 5m, 7.5m, 8m.
2. Min. length of connection pipe is 3m.
3. Max. length of connection pipe and max. rising difference.

Cooling capacity	Max length of connection pipe	Max rising difference
9000Btu/h (2637W)	20	10
12000Btu/h (3516W)	20	10
18000Btu/h (5274W)	25	10

Cooling capacity	Max length of connection pipe	Max rising difference
24000Btu/h (7032W)	25	10
28000Btu/h (8204W)	30	10
36000Btu/h (10548W)	30	20
42000Btu/h (12306W)	30	20
48000Btu/h (14064W)	30	20

Configuration of connection pipe

4. Additional refrigerant liquid and refrigerant charging required after extending connection pipe

- The calculation method of additional refrigerant charging amount (on the basis of liquid pipe):
 Additional refrigerant charging quantity = prolonged length of liquid pipe x additional refrigerant charging amount per meter
- Based on the length and diameter of standard pipe, add refrigerant as per the following chart.

Additional refrigerant charging amount for , R410A

Diameter of connection pipe		Outdoor unit throttle	
Liquid pipe (mm)	Gas pipe (mm)	Cooling only(g/m)	Cooling and heating(g/m)
∅6	∅9.52 or ∅12	15	20
∅6 or ∅9.52	∅16 or ∅19	15	50
∅12	∅19 or ∅22.2	30	120
∅16	∅25.4 or ∅31.8	60	120
∅19	-	250	250
∅22.2	-	350	350

Pipe expanding method

Note:

Improper pipe expanding is the main cause of refrigerant leakage. Please expand the pipe according to the following steps:

A: Cut the pipe

- Confirm the pipe length according to the distance of indoor unit and outdoor unit.
- Cut the required pipe with pipe cutter.

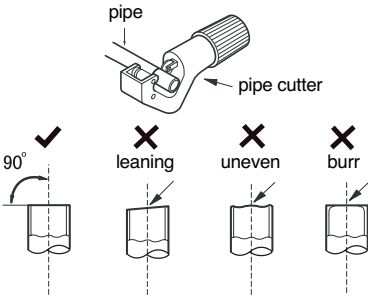

B: Remove the burrs

- Remove the burrs with shaper and prevent the burrs from getting into the pipe.

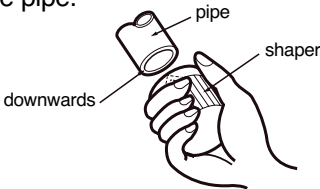

C: Put on suitable insulating pipe

D: Put on the union nut

- Remove the union nut on the indoor connection pipe and outdoor valve; install the union nut on the pipe.

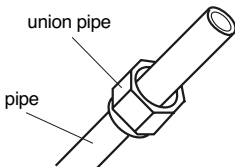

E: Expand the port

- Expand the port with expander.

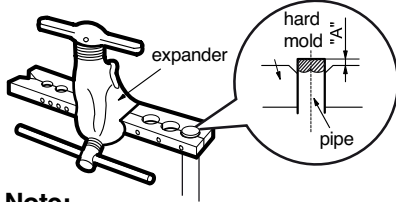

Note:

- "A" varies according to the diameter, please refer to the sheet below:

Outer diameter (mm)	A (mm)	
	Max	Min
∅6-6.35(1/4")	1.3	0.7
∅9.52(3/8")	1.6	1.0
∅12-12.7(1/2")	1.8	1.0
∅15.8-16(5/8")	2.4	2.2

F: Inspection

- Check the quality of expanding port. If there is any blemish, expand the port again according to the steps above.

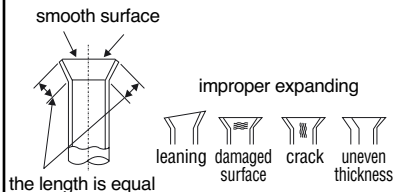

Wired Remote Control

Note: The Wired Remote Control is only available on some models.

1 LCD Symbols



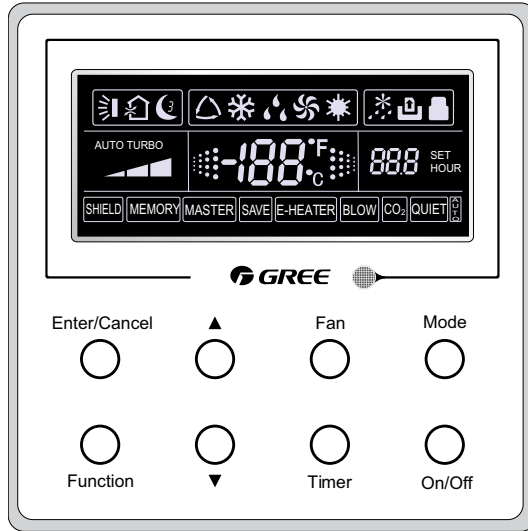



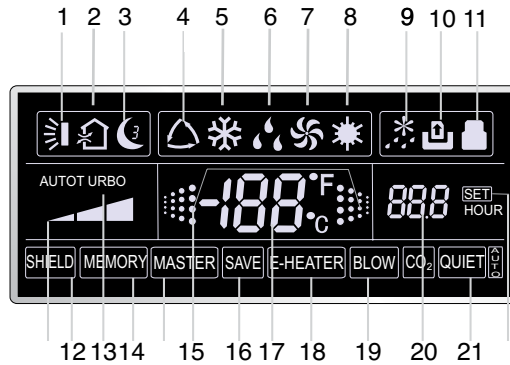







1.1 Outside View of the Wired Remote Control



1.2 Wired Remote Control LCD Screen



Wired Remote Control

No.	Symbols	Description
1		Swing function.
2		Air exchange function (not available on this model)
3		Sleep function (only Sleep 1)
4		Indoor unit running modes (Cool, Dry, Fan and Heat)
5		Cooling mode
6		Dry mode
7		Fan mode
8		Heating mode
9		Outdoor unit defrosting function
10		Gate-control function (not available for this unit)
11		Lock function.
12	SHIELD	Shield functions : buttons, temperature, On/Off or Mode is shielded by the remote monitor
13	AUTO TURBO	Turbo function.
14	MEMORY	Memory function (the indoor unit resumes the original setting after power failure and power recovery)
15		Blinks under ON status of the unit without touching any button.
16	SAVE	Energy-saving function (not available for this unit)
17		Ambient/Presets temperature value
18	E-HEATER	Electric auxiliary heating function.
19	BLOW	Blow function.
20		Time value
21	QUIET	Quiet function (two types: Quiet and Auto Quiet) (not available for this unit)

Wired Remote Control

2 Buttons

2.1 Wired Remote Control Buttons

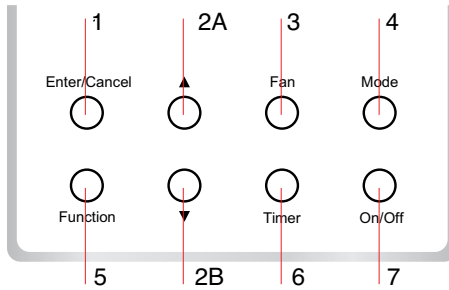

2.2 Button Functions

1	Enter/Cancel	Select and cancel a function
2A	▲	Set running temperature for the indoor unit, range: 16 ~ 30°C and Set timer, range: 0.5 – 24 hr.
2B	▼	
3	Fan	Set fan speed: High/Middle/Low/Auto
4	Mode	Set indoor unit mode: Cool/Heat/Fan/Dry/Auto
5	Function	Switch functions: Turbo/Save/E-heater/Blow etc.
6	Timer	Set timer
7	On/Off	Turn indoor unit on/off
4+2A	▲+Mode	Press together for 5 sec. when the unit is off to Enter/Cancel the Memory function. If Memory is set, the indoor unit will go back to the original setting after a power failure and power recovery. If not, the indoor unit will turn off by default after power recovery. Memory is set to off as default at time of delivery.
3+2B	Fan+▼	Press together when the unit is off, ☒ is displayed on the wired remote control for a cooling only unit, while ☒ is displayed on the wired remote control for a cooling and heating unit.
2A+2B	▲+▼	When starting the unit , press together for 5 sec. to turn on the Lock, which means that buttons are locked and disabled. Press together again for 5 sec. to unlock.

3 Operating Instructions

3.1 On/Off

Press "On/Off" to turn the unit on. Turn it off by pressing it again.

Note: Fig.4 shows that the unit is off after the on/off button has been pressed.

Fig.5 shows that the unit is on after the on/off button has been pressed again.

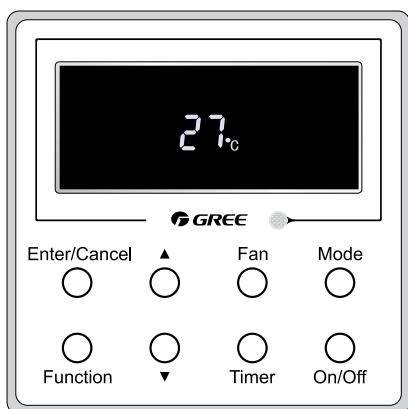

Fig. 4 "Off" Status

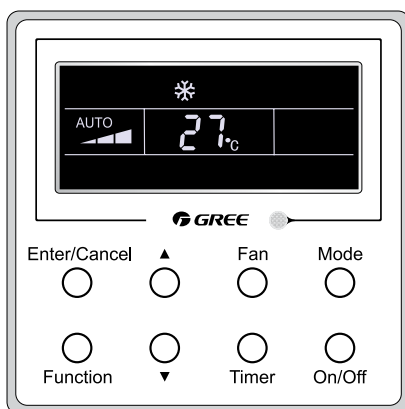

Fig. 5 "On" Status

3.2 Mode Setting

When the unit is on, press "Mode" to change operating modes in the following sequence:



3.3 Temperature Setting

Press ▲ or ▼ to increase/decrease the preset temperature. Hold either button down to increase or decrease the temperature by 1°C every 0.5 sec., as shown in Fig.6. In the Cool, Dry, Fan or Heat mode, the temperature setting range is 16°C-30°C. In Auto mode, the temperature is not adjustable.

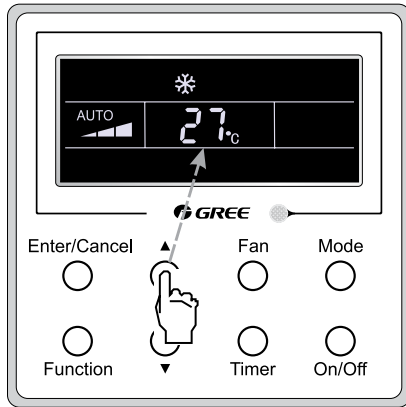

Fig.6

3.4 Fan Setting

When the unit is on or off, press “Fan” to change the fan speed on the indoor unit in the sequence shown in Fig.7.

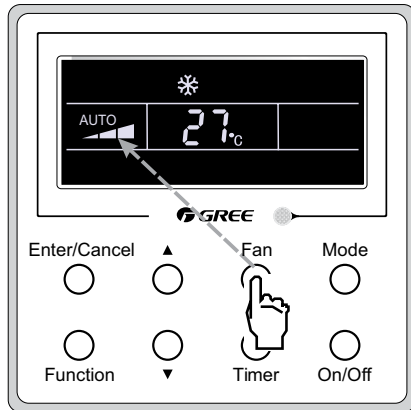
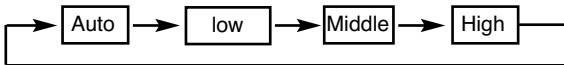

Fig.7

3.5 Timer Setting

When the unit is on or off, press “Timer” to set the time when the unit will go on or off. To set Timer On: press “Timer” and the LCD will display “xx.x hour,” with “hour” flashing. Press ▲ or ▼ to change the time value. Then press Enter/Cancel to confirm the setting.

To set Timer Off: press “Timer”. If the LCD doesn’t display “xx.x hour,” it means the timer setting is canceled.

Setting the Timer Off time with the unit on is shown in Fig.8.

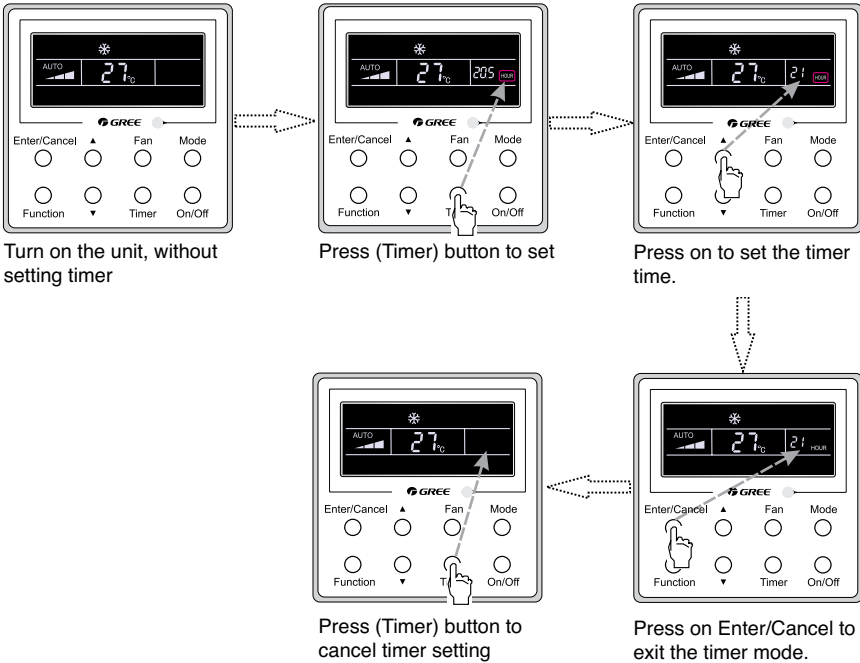



Fig. 8 Setting Timer When Unit Is on

Timer range: 0.5 – 24hr. Each time ▲ or ▼ is pressed, the time setting increases or decreases by 0.5 hr. If either button is held down, the time setting will increase/ decrease by 0.5 hr every 0.5 sec.

3.6 Swing Setting

Swing On: With the unit on, press “Function” to activate the swing function. In this case,  will flash. Press Enter/Cancel to confirm.

Swing Off: When the Swing function is on, press “Function” to enter the Swing setting interface, with  flashing. Press Enter/Cancel to cancel this function.

How to set the Swing function is shown in Fig.9.

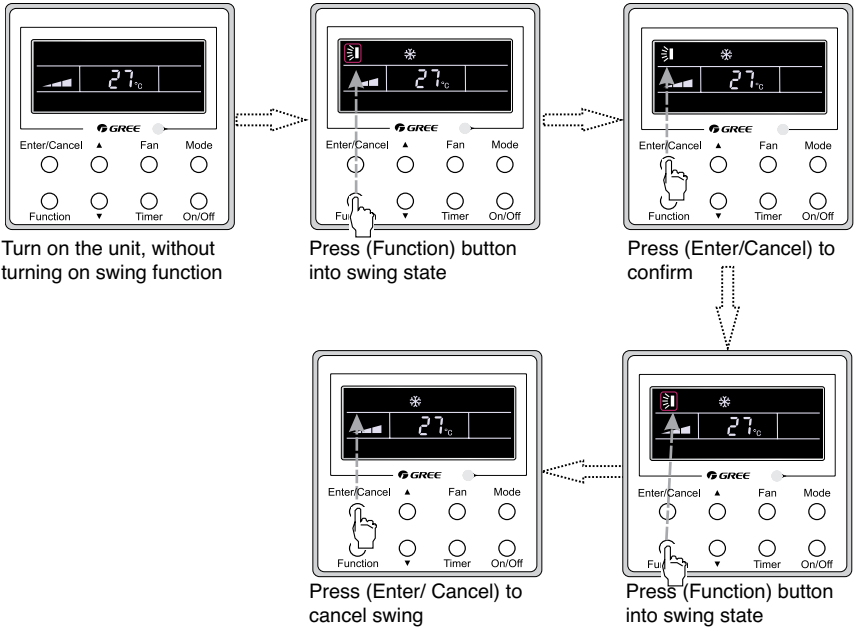

Fig. 9 Setting the Swing Function

Note :

- ① .Sleep, Turbo and Blow are set in the same way as setting the Swing function.
- ② .When Swing is set, press “Enter/Cancel” to go back to the setting status or the remote control will automatically go to the setting status after 5 sec.

3.7 Sleep Setting

Sleep On: With the unit on, press “Function” until you arrive at the Sleep setting interface. Press “Enter/Cancel” to confirm the setting.

Sleep Off: When the Sleep function is activated, press “Function” to enter the Sleep setting interface. Press “Enter/Cancel” to cancel.

When running in the Cool or Dry mode, the temperature will increase by 1°C when the unit has been in Sleep 1 for 1 hr and 1°C after another 1 hr. After that, the unit will continue to run at this temperature.

When running in the Heat mode, the temperature will decrease by 1°C when the unit has been in Sleep 1 for 1 hr and 1°C after another 1 hr.

After that, the unit will continue to run at this temperature.

How to set the Sleep function is shown in Fig.10.

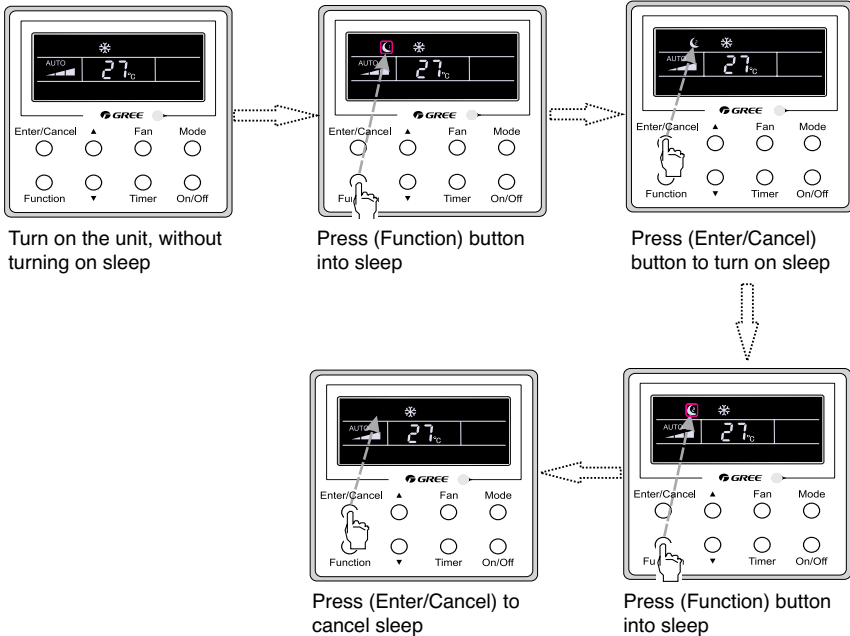

Fig. 10 Setting the Sleep Function

3.8 Turbo Setting

Turbo function: When the unit is set to High fan speed it will cool or heat more quickly, thus reaching the set temperature more quickly. When running in the Cool or Heat mode, press “Function” until you arrive at the Turbo setting interface. Press “Enter/Cancel” to confirm. When the Turbo function is activated, press “Function” to enter the Turbo setting interface. Press “Enter/Cancel” to cancel. How to set the Turbo function is shown in Fig.11.

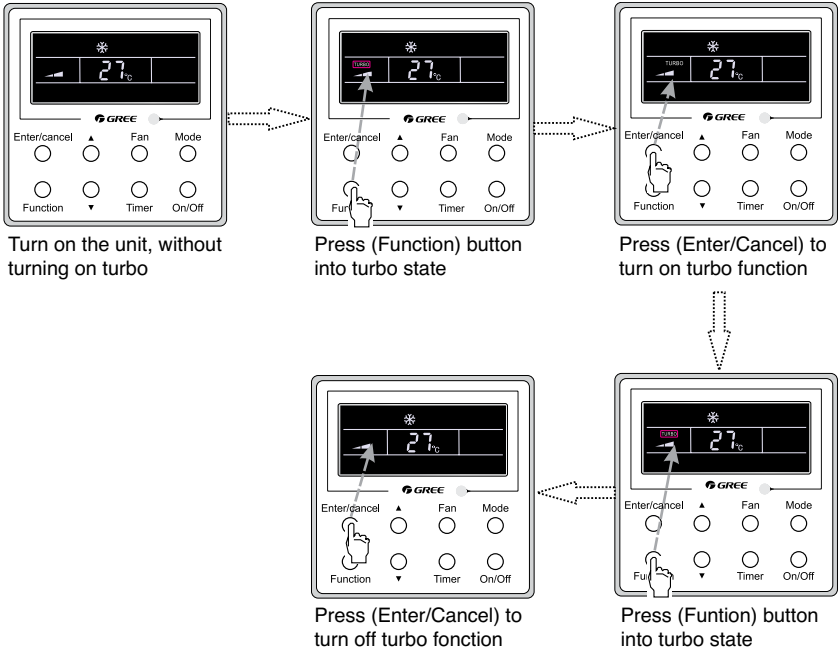

Fig.11 Setting the Turbo Function

3.9 E-heater Setting

E-heater (auxiliary electric heating function): When running in the Heat mode, the E-heater can be turned on to improve efficiency.

When the wired remote control or the remote control is set in the Heat mode, this function will turn on automatically.

When running in the Heat mode, press “Function” to enter the E-heater setting interface. Press “Enter/Cancel” to cancel this function.

If the E-heater function is not activated, press “Function” to enter the E-heater setting interface. Press “Enter/Cancel” to turn it on.

How to set this function is shown in Fig.12

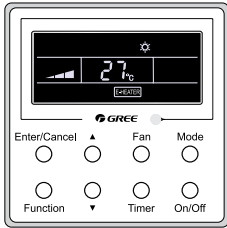

Auxilliary electric heating function is automatically on in Heating mode

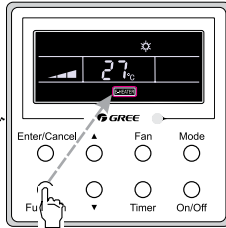

Press (Function) button into this function

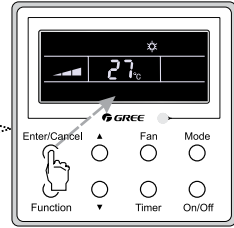

Press (Enter/Cancel) button to turn off this function

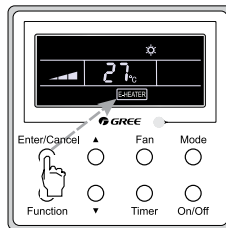

Press (Enter/Cancel) button to turn on this function

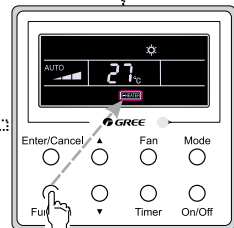

Press “Function” until E-heater

3.10 Blow Setting

Blow function: When the unit is turned off, the water in the indoor unit's evaporator automatically evaporates to prevent mildew.

When running in the Cool or Dry mode, press "Function" until reaching the Blow setting interface. Press "Enter/Cancel" to activate this function.

When the Blow function is activated, press "Function" until reaching the Blow setting interface. Press "Enter/Cancel" to cancel this function.

How to set the Blow function is shown in Fig.13.

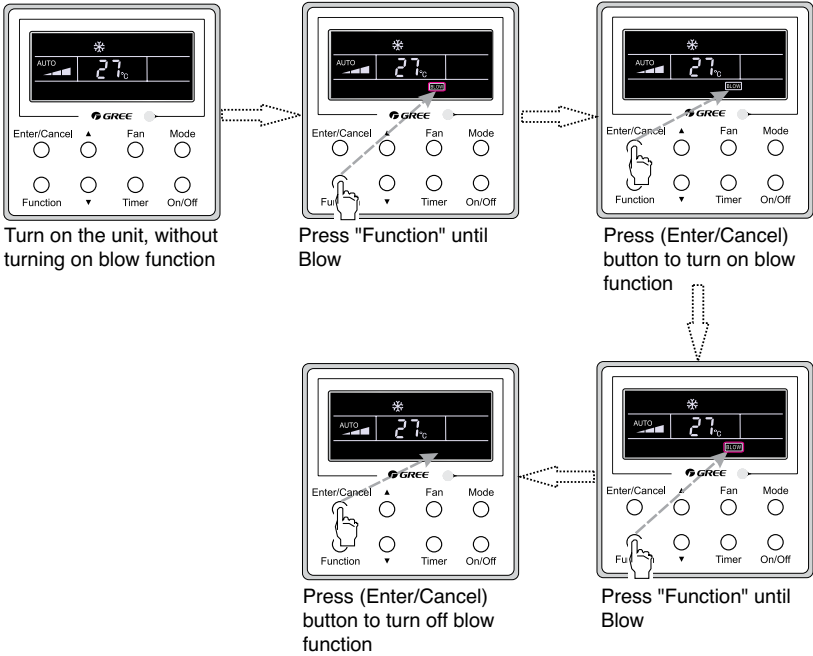



Fig.13 Setting the Blow Function

Notes :

- ① . When the Blow function is activated and the unit is turned off by pressing "On/Off" or with the remote control, the indoor fan will run at Low fan speed for 2 min., with "Blow" showing on the LCD screen. If the Blow function is deactivated, the indoor fan will turn off right away
- ② . The Blow function is not available in the Fan or Heat mode.

3.11 Other Functions

(1). Lock

When starting the unit , press ▲ and ▼ at the same time for 5 sec. until the wired remote control enters the Lock function. The LCD screen will display . Press these two buttons at the same time again for 5 sec. to unlock. When Lock is on, nothing will happen if a button is pressed.

(2) Memory

Memory switch: When the unit is off, press “Mode” and ▲ at the same time for 5 sec. to switch between Memory On and Memory Off. When this function is activated, Memory will be displayed. If this function is not set, the unit stays off after a power failure and power recovery.

Memory recovery: If this function has been set for the wired remote control, the wired remote control after power failure will resume its original running state upon power recovery. Memory contents: On/Off, Mode, set temperature, set fan speed and Lock function.

4 Installation and Disassembly

4.1

Connecting the Signal Line on the Wired Remote Control

- Open the cover of the indoor unit's electrical control box.
- Pass the signal line of the wired remote control through the rubber ring.
- Connect the signal line of the wired remote control to the 4-pin socket of the indoor unit's PCB.
- Tighten the signal wire with ties.
- The communication distance between the main board and the wired remote control can be up to 20 meters. (The standard distance is 8 meters.)

4.2 Installing the Wired Remote Control

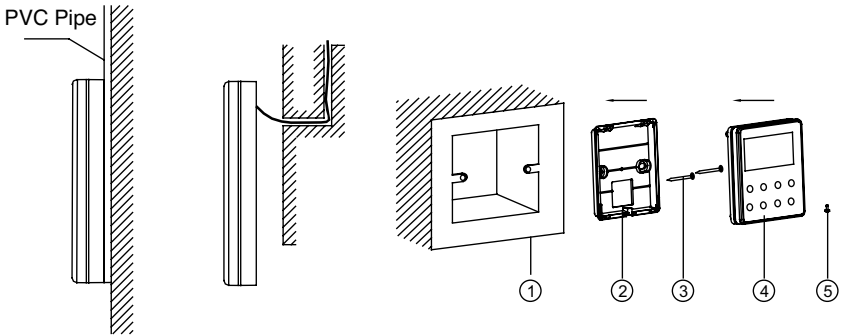

Fig.Accessories to Install the Wired Remote Control

Table 3

No.	1	2	3	4	5
Name	Socket box embedded in the wall	Soleplate of the Wired Remote Control	Screw M4X25	Front Panel of the Wired Remote Control	Screw ST2.9X6

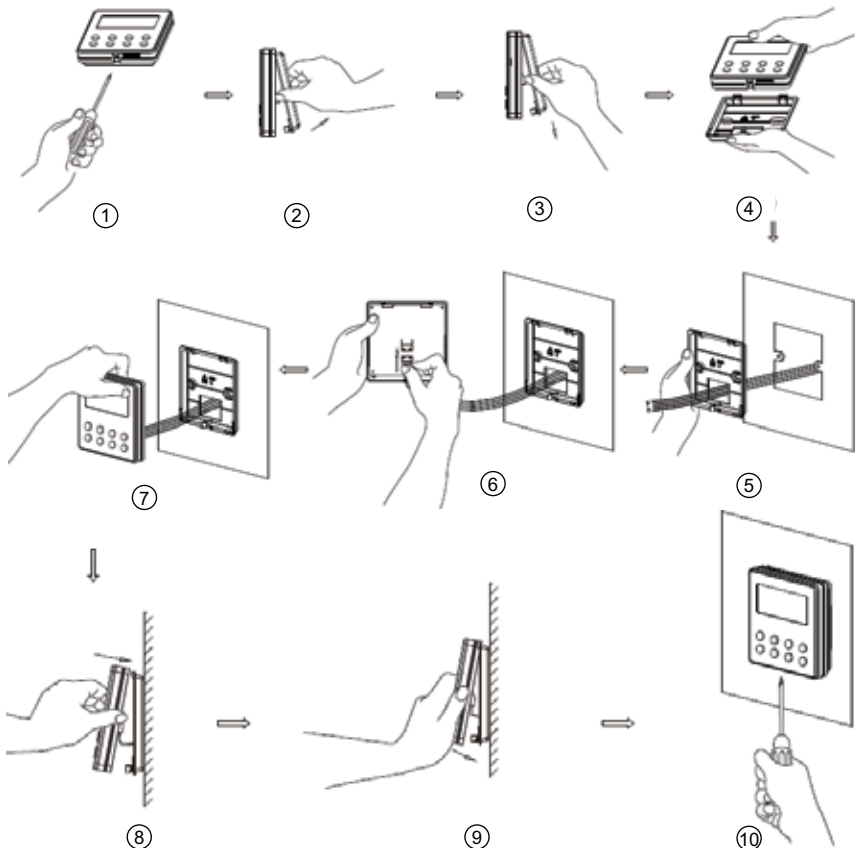

Fig. 15

Fig.15 shows the installation steps for the wired remote control, but the following elements must also be taken into account.

- (1) Prior to installation, first turn off the power supply, that is, do not use electricity during the entire installation.
- (2) Pull out the twisted four-core pair line from the installation holes and then pass it through the rectangular hole behind the soleplate on the wired remote control.
- (3) Attach the wired remote control soleplate to the wall over the installation hole and then affix it with M 4X25 screws.
- (4) Insert the twisted four-core pair line into the slot on the wired remote control and then buckle the front panel and the soleplate together.
- (5) Finally, attach the front panel and the soleplate of the wired remote control tightly with ST 2.9X6 screws.

⚠ CAUTION!

Pay special attention to the following during connection to prevent the air conditioner from malfunctioning due to electromagnetic interference.

- ① Separate the signal and communication lines of the wired remote control from the power wire and connection lines between the indoor and outdoor units, by a minimum interval of 20 cm, or the communication between the units will likely malfunction.
- ② If the air conditioning unit is installed where it is vulnerable to electromagnetic interference, then the signal and communication lines for the wired remote control must be shielding twisted pair lines.

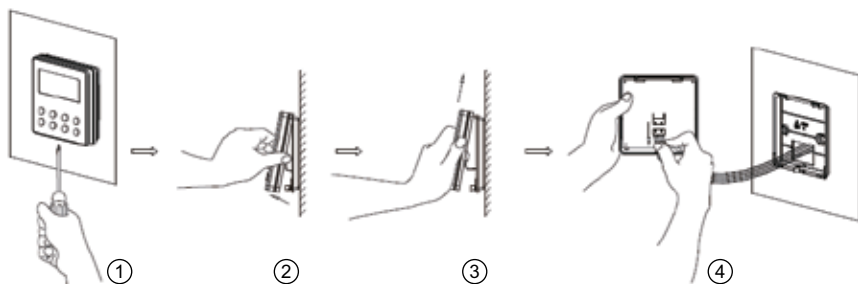
4.3 Disassembling the Wired Remote Control**5 Errors Display**

If an error occurs when running the system, the error code will be displayed on the LCD screen, as shown in Fig.16. If multiple errors occur at the same time, their codes will be displayed in a sequence.

Note: In the event of an error, turn off the unit and contact a professional technician

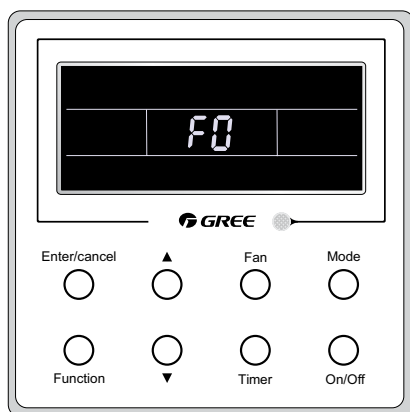

Fig. 16

DEFINITION OF ERROR CODES

Return air temperature sensor open/short circuited	F1	Drive board communication error	P6
Evaporator temperature sensor open/short circuited	F2	Compressor overheating protection	H3
Indoor unit liquid valve temperature sensor open/short circuited	B5	Indoor and outdoor units not matched	LP
Indoor gas valve temperature sensor open / short circuited	B7	Communication line misconnected or expansion valve error	DN
IPM temperature sensor open/short circuited	P7	Running mode conflict	E7
Outdoor ambient temperature sensor open/short circuited	F3	Pump-down	FO
Outdoor unit condenser mid-tube temperature sensor open/short circuited	F4	Jumper Error	C5
Discharge temperature sensor open/short circuited	F5	Forced defrosting	H1
Indoor-outdoor communication error	E6	Compressor startup failure	LC
DC bus under-voltage protection	PL	High discharge temperature protection	E4
DC bus over-voltage protection	PH	Overload protection	E8
Compressor phase current sensing circuit error	U1	Whole unit over-current protection	E5
Compressor demagnetization protection	HE	Over phase current protection	P5
PFC protection	HC	Compressor desynchronizing	H7
IPM temperature protection	P8	IPM current protection	H5
Over-power protection	L9	Compressor phase loss/reversal protection	LD
System charge short age or blockage protection	F0	Frequency restricted/reduced with whole unit current protection	F8
Capacitor charging error	PU	Frequency restricted/reduced with IPM current protection	EN
High pressure protection	E1	Frequency restricted/reduced with high discharge temperature	F9
Low pressure protection	E3	Frequency restricted/reduced with anti-freezing protection	FH
Compressor stalling	LE	Frequency restricted/reduced with overload protection	F6
Over-speeding	LF	Frequency restricted/reduced with IPM temperature protection	EU
Drive board temperature sensor error	PF	Indoor unit water full	E9
AC contactor protection	P9	Anti-freezing protection	E2
Temperature drift protection	PE	AC input voltage abnormal	PP
Sensor connection protection	PD	Whole unit current sensing circuit error	U5
DC bus voltage drop error	U3	4-way valve reversing error	U7
Outdoor fan 1 protection error	L3	Motor stalling	H6
Outdoor fan 2 protection error	LA	PG motor zero-crossing protection	U8

